

SERVICE MANUAL

INTEGRATED STEREO AMPLIFIER

SANSUI AU-3900/4900



Sansui

SANSUI ELECTRIC CO., LTD.

This service manual is designed for service engineers to repair, adjust, maintain and order the replacement parts of AU-3900 and AU-4900 correctly.

When ordering the parts, use the stock number and parts name specifically referring to the Parts Location & Parts Lists.

For general usage and maintenance of the unit, please refer to the Operating Instructions attached with the unit.

TABLE OF CONTENTS

<u>Section</u>	<u>Title</u>	<u>Page</u>
1.	SPECIFICATIONS	2
1-1.	AU-3900	2
1-2.	AU-4900	2
2.	ADJUSTMENTS	3
2-1.	Bias Current Adjustment	3
3.	OTHER PARTS (Top Side)	4
4.	OTHER PARTS (Front Side)	5
5.	PARTS LOCATION AND PARTS LISTS	6
5-1.	F-2555 Tone Control Circuit Board	6
5-2.	F-2554 Driver Circuit Board	7
5-3.	F-2556 Switch Circuit Board	7
5-4.	F-2587 Connector Circuit Board	8
6.	FIGURES	8
7.	TROUBLESHOOTING	8
7-1.	Troubleshooting Chart	8
7-2.	Operation Block Diagram	8
8.	SCHEMATIC DIAGRAM	9
8-1.	AU-3900	9
8-2.	AU-4900	10
9.	PACKING LIST	11
10.	ACCESSORY PARTS LIST	11

1. SPECIFICATIONS

1-1. AU-3900

POWER OUTPUT

Min. RMS, both channels driven, from 40 to 20,000Hz, with no more than 0.15% total harmonic distortion

22 watts per channel into 8 ohms

Min. RMS, both channels driven, at 1,000Hz, with no more than 0.15% total harmonic distortion
25 watts per channel into 8 ohms

LOAD IMPEDANCE 8 ohms (SYSTEM-A or B)

POWER BANDWIDTH 40 to 20,000Hz at or below rated min. RMS power output and total harmonic distortion

TOTAL HARMONIC DISTORTION less than 0.15% at or below rated min. RMS power output

INTERMODULATION DISTORTION (70Hz:7kHz=4:1 SMPTE method) less than 0.2%

FREQUENCY RESPONSE (at 1 watt) 10 to 40,000Hz $\pm_{1.5}^{0.5}$ dB

DAMPING FACTOR approximately 50 at 8 ohms load

INPUT SENSITIVITY AND IMPEDANCE

(1 kHz, for rated power output)

PHONO 2.5 mV/50 kilo-ohms
(Max. input capability: 200 mV at 1 kHz, less than 0.2% total harmonic distortion)

MIC 2.5 mV/10 kilo-ohms

TUNER 130 mV/50 kilo-ohms

AUX 130 mV/50 kilo-ohms

TAPE PLAY (pin jacks) 130 mV/50 kilo-ohms

OUTPUT LEVEL (1,000Hz)

TAPE REC (pin jacks) 100 mV

CHANNEL SEPARATION (1 kHz, at rated power output)

PHONO better than 60dB

TUNER better than 65dB

AUX better than 65dB

TAPE PLAY better than 65dB

HUM AND NOISE (IHF)

PHONO better than 75dB

TUNER better than 90dB

AUX better than 90dB

TAPE PLAY better than 90dB

MIC better than 65dB

CONTROLS

BASS +12dB, -12dB (50Hz)

TREBLE +12dB, -12dB (15 kHz)

LOUDNESS (volume control: -30dB) +10dB (50Hz) +8dB (10 kHz)

HIGH FILTER -3dB (7 kHz, 6dB/oct.)

POWER REQUIREMENTS

POWER VOLTAGE 100, 120, 220, 240V 50/60Hz
120V (Usable 110~130V)
(for U.S.A. & Canada only)

POWER CONSUMPTION 60 watts (rated)
170 watts (max.), (194 VA)

DIMENSIONS 400 mm (15 $\frac{3}{4}$ " W

120 mm (4 $\frac{3}{4}$ " H

240 mm (9 $\frac{1}{2}$ " D

WEIGHT 5.5 kg (13.2 lbs) net
7.0 kg (15.4 lbs) packed

1-2. AU-4900

POWER OUTPUT

Min. RMS, both channels driven, from 40 to 20,000Hz, with no more than 0.15% total harmonic distortion

35 watts per channel into 8 ohms

Min. RMS, both channels driven, at 1,000Hz, with no more than 0.15% total harmonic distortion
38 watts per channel into 8 ohms

LOAD IMPEDANCE 8 ohms (SYSTEM-A or B)

POWER BANDWIDTH 40 to 20,000Hz at or below rated min. RMS power output and total harmonic distortion

TOTAL HARMONIC DISTORTION less than 0.15% at or below rated min. RMS power output

INTERMODULATION DISTORTION (70Hz:7kHz=4:1 SMPTE method) less than 0.2%

FREQUENCY RESPONSE (at 1 watt) 10 to 40,000Hz $\pm_{1.5}^{0.5}$ dB

DAMPING FACTOR approximately 50 at 8 ohms load

INPUT SENSITIVITY AND IMPEDANCE

(1 kHz, for rated power output)

PHONO 2.5 mV/50 kilo-ohms
(Max. input capability: 230 mV at 1 kHz, less than 0.2% total harmonic distortion)

MIC 2.5 mV/10 kilo-ohms

TUNER 130 mV/50 kilo-ohms

AUX 130 mV/50 kilo-ohms

TAPE PLAY (pin jacks) 130 mV/50 kilo-ohms

OUTPUT LEVEL (1,000Hz)

TAPE REC (pin jacks) 100 mV

CHANNEL SEPARATION (1 kHz, at rated power output)

PHONO better than 60dB

TUNER better than 65dB

AUX better than 65dB

TAPE PLAY better than 65dB

HUM AND NOISE (IHF)

PHONO better than 75dB

TUNER better than 90dB

AUX better than 90dB

TAPE PLAY better than 90dB

MIC better than 65dB

CONTROLS

BASS +12dB, -12dB (50Hz)

TREBLE +12dB, -12dB (15kHz)

LOUDNESS (volume control: -30dB) +10dB (50Hz) +8dB (10 kHz)

LOWER FILTER -3dB (100Hz, 6dB/oct.)

HIGH FILTER -3dB (7 kHz, 6dB/oct.)

POWER REQUIREMENTS

POWER VOLTAGE 100, 120, 220, 240V 50/60Hz
120V (Usable 110~130)
(for U.S.A. & Canada only)

POWER CONSUMPTION 90 watts (rated)
240 watts (max.), (274 VA)

DIMENSIONS 400 mm (15 $\frac{3}{4}$ " W

120 mm (4 $\frac{3}{4}$ " H

240 mm (9 $\frac{1}{2}$ " D

WEIGHT 6.3 kg (14.8 lbs) net
7.7 kg (17.0 lbs) Packed

2. ADJUSTMENTS

2-1. Bias Current Adjustment

- Note: 1. Confirm the AC Power Supply voltage.
 2. Master Volume.....Minimum
 3. Room Temperature18C°~28°C
 (65°F~83°F)

4. For this adjustment, run the unit for more than 3 minutes after power is switched ON.
 5. Before this adjustment, turn VR01 and VR02 fully counterclockwise.

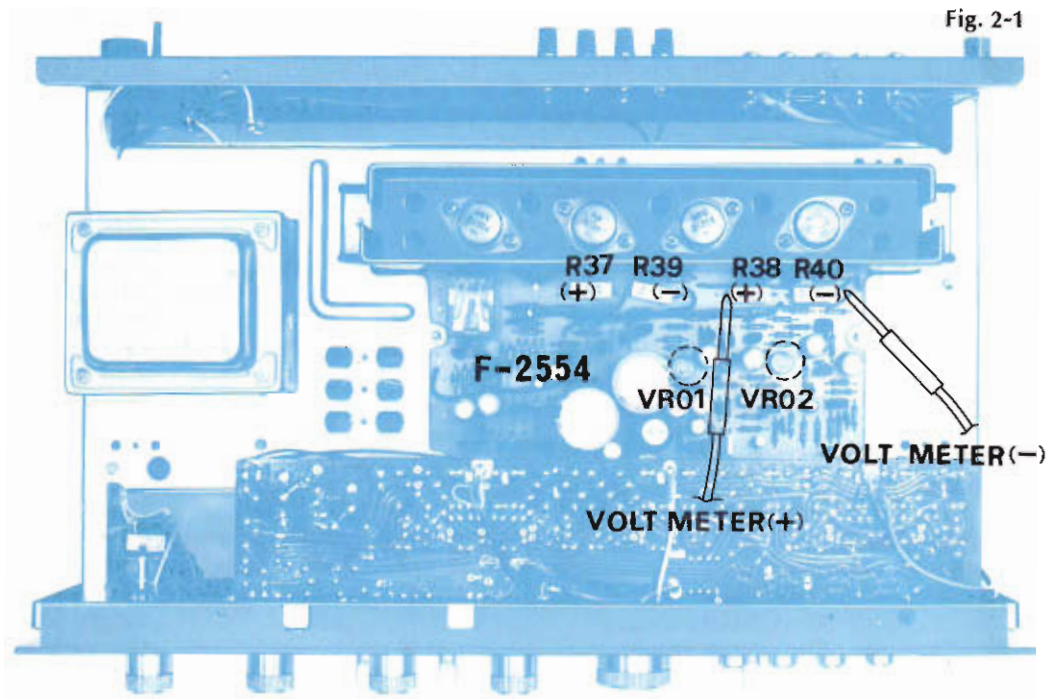

Fig. 2-1

STEP	SUBJECT	EQUIPMENT	MEASURE OUTPUT	ADJUST	ADJUST FOR
1	Bias Current L-CH	DC Volt meter	* 1) See below	VR01 F-2554 (See Fig. 2-1)	13mV ±1mV
2	Bias Current R-CH	DC Volt meter	* 2) See below	VR02 F-2554 (See Fig. 2-1)	13mV ±1mV

*1) For this measurement, put the lead (+) side of volt meter to (+) side of R37 and the lead (-) side to (-) side of R39 on F-2554 as Fig. 2-1.

*2) For this measurement, put the lead (+) side of volt meter to (+) side of R38 and the lead (-) side to (-) side of R40 on F-2552 as Fig. 2-1.

(F-2459 Driver Circui Board)

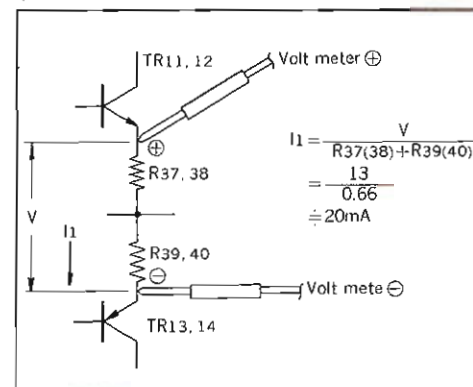

3. OTHER PARTS (Top Side)

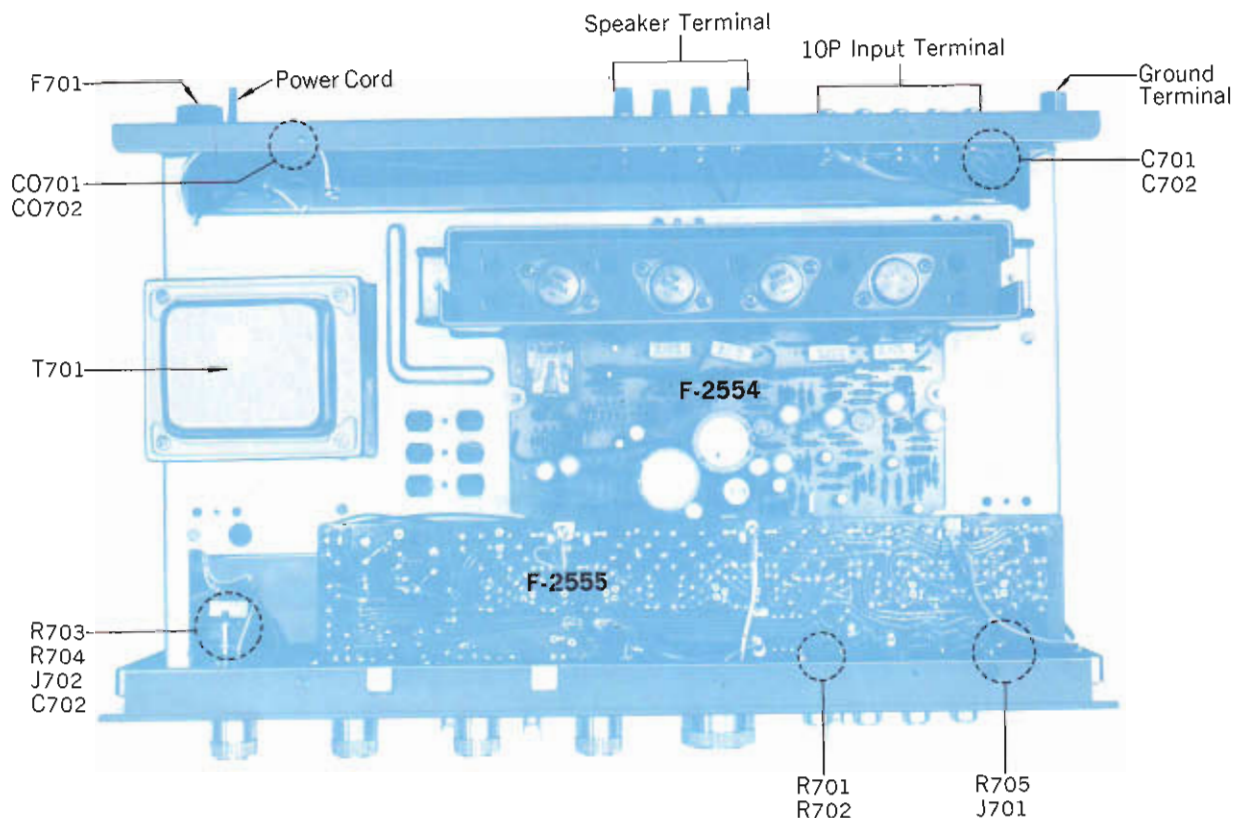

Parts List (AU-3900, 4900)

Parts No.	Stock No.	Description
C701	0657473	47000pF 50V C.C.
C702	0659801	0.01 μ F 150V C.C.
C703	0657473	47000pF 50V C.C.
R703	0104331	330 Ω } 1 W C.R.
R704	0104331	
CO701	2450060	AC Outlet
CO702	2450060	AC Outlet
J701	2430170	Microphone Jack
J702	2430190	Headphone Jack
	2200350	10P Input Terminal
	2210200	Speaker Terminal
	3800261	Power Cord
	3910490	Power Cord Clip
	2230651	Ground Terminal
	2410091	Voltage Selector, Socket
	2410830	Voltage Selector, Plug

Parts List (AU-3900 only)

Parts No.	Stock No.	Description
R701	0107102	1k Ω 1/4 W C.R.
T701	4002330	Power Transformer
F701	{ 0431230 0431250 2300060	1.5A 250V AC Fuse 2.5A 250V AC Fuse Fuse Holder

Parts List (AU-4900 only)

Parts No.	Stock No.	Description
R701	0107822	8.2k Ω } 1/4 W C.R.
R702	0107822	
R705	0107102	
T701	4002320	Power Transformer
F701	{ 0431240 0431260 2300060	2A 250V AC Fuse 3A 250V AC Fuse Fuse Holder

4. OTHER PARTS (Front Side)

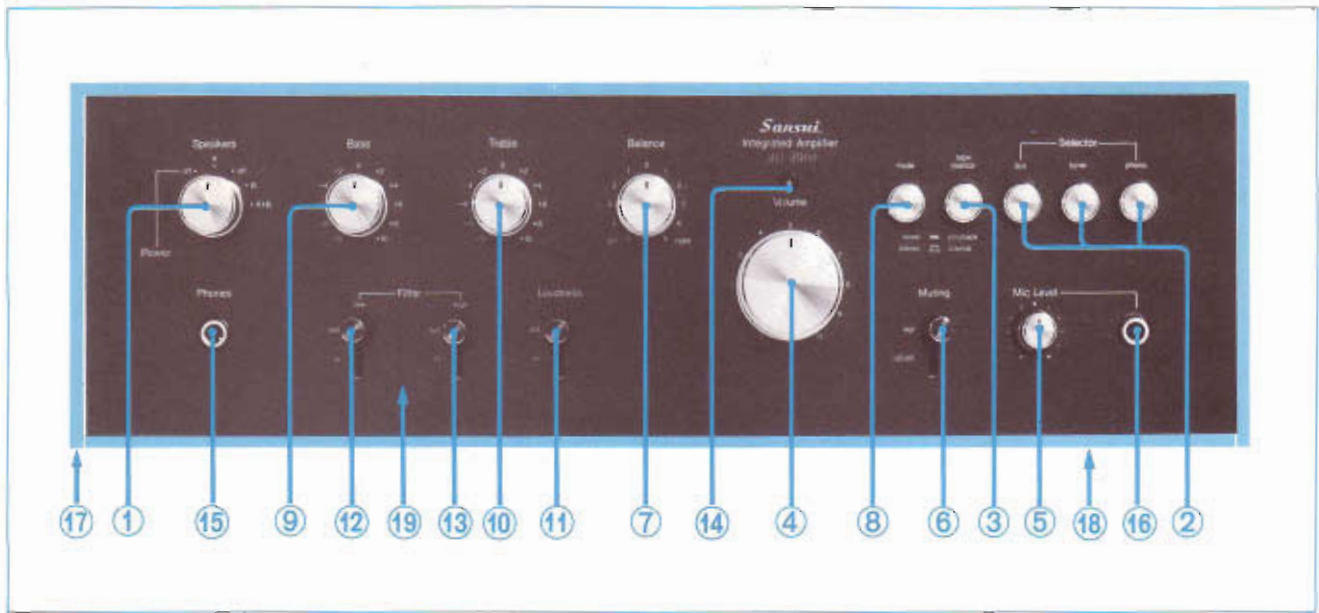

Parts List (AU-3900, 4900)

Parts No.	Stock No.	Description
1	{ 5317880	S-5 Type Knob, SPEAKERS
	{ 1101550, 1	Rotary Switch Y-1-4-5, SPEAKERS
2	{ 5326500	Push Button (B)
	{ 5396190	Ring, push button
	{ 1131120	Push Switch (SUB 54)
3	{ 5326500	Push Button (B)
	{ 5396190	Ring, push button
	{ 1131120	Push Switch (SUB 54)
4	{ 5318630	L-4 Type Knob, VOLUME
	{ 1011070, 1	250kΩ(B) × 2 VOLUME
5	{ 5318620	Y-6 Type Knob, MIC LEVEL
	{ 1005120, 1	10kΩ MIC LEVEL Volume
7	{ 5318610	S-11 Type Knob, BALANCE Volume
	{ 1015070, 1	100kΩ(MN) × 2 BALANCE Volume
8	{ 5326500	Push Button (B)
	{ 5396190	Ring, push button
	{ 1131120	Push Switch (SUB 54)
9	{ 5317880	S-5 Type Knob, BASS Volume
	{ 1015080, 1	100kΩ (A) × 2 BASS Volume
10	{ 5317880	S-5 Type Knob, TREBLE Volume
	{ 1015080, 1	100kΩ (A) × 2 TREBLE Volume
11	{ 5326520	E-3 Type Knob, LOUDNESS
	{ 5047460	Masking, lever switch
	{ 1170340	SX15-5 Lever Switch, LOUDNESS
13	{ 5326520	E-3 Type Knob, H
	{ 5047460	Masking, lever switch
	{ 1170350	SX15-6 Lever Switch, HIGH FILTER
14	7726080	Light Emitted Diode Ass'y (A)
15	2430190	Headphone Jack
16	2430170	Microphone Jack
17	5006460	Metal Bonnet
18	5058191	Bottom Plate

Parts List (AU-3900 only)

Parts No.	Stock No.	Description
19	5304410	Front Panel

Parts List (AU-4900 only)

Parts No.	Stock No.	Description
6	{ 5326520	E-3 Type Knob, lever switch
	{ 5047460	Masking, lever switch
	{ 1170390	SX15-10 Lever Switch, MUTING
12	{ 5326520	E-3 Type Knob, Low FILTER
	{ 5047460	Masking, lever switch
19	{ 1170340	SX15-5 Lever Switch, LOW FILTER
	{ 5304400	Front Panel

5. PARTS LOCATION AND PARTS LISTS

5-1. F-2555 Tone Control Circuit Board (Stock No. 7561041 Complete Circuit Board F-2555 . . . AU-3900)
 (Stock No. 7561051 Complete Circuit Board F-2555 . . . AU-4900)

Conductor
Side

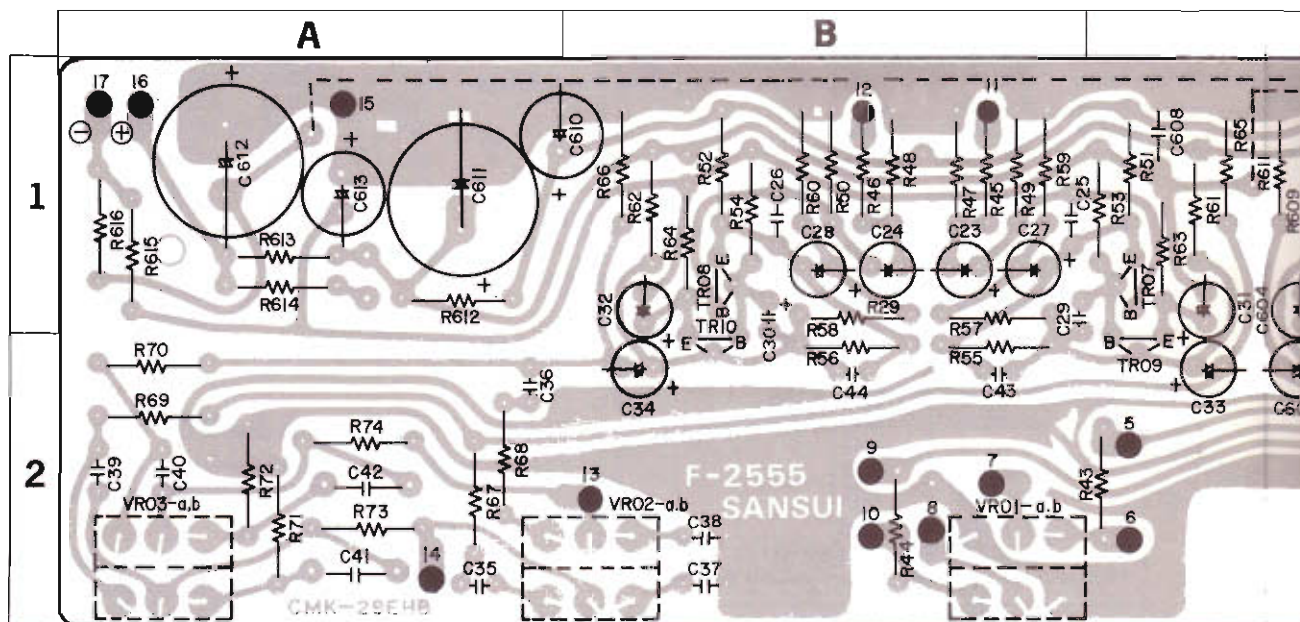

Parts List (AU-3900, 4900)

Parts No.	Stock No.	Description	Position
TR01, 02	0300470, 1	2SA726 (F, G)	1 E, 1 D
TR03, 04	0306070, 1	2SC1313 (F, G)	2 E, 2 D
TR05, 06	0300470, 1	2SA726 (F, G)	1 B
TR07, 08	0300470, 1	2SA726 (F, G)	1 C, 1 B
TR09, 10	0306070, 1	2SC1313 (F, G)	2 C, 2 B
TR601	0300470, 1	2SA726 (F, G)	1 C
TR602	0306070, 1	2SC1313 (F, G)	1, 2 C
C01, 02	0519101	1 μ F 50V E.C.	1 E
C03, 04	0660151	150pF 50V C.C.	1E, 1D, E
C05, 06	0510101	100 μ F 6.3V E.C.	1 E
C07, 08	0600207	0.02 μ F	2 E
C09, 10	0600686	0.0068 μ F	2 E
C11, 12	0660330	33pF 50V C.C.	1 E, 1 D
C13, 14	0510470	47 μ F 6.3V E.C.	1 E, 1 D
C15, 16	0519101	1 μ F	1, 2E, 2 D
C17, 18	0519103	0.47 μ F	1 D
C19, 20	0660470	47pF 50V C.C.	1 D
C21, 22	0515339	3.3 μ F	1 D
C23, 24	0519101	1 μ F	1 B
C25, 26	0660151	150pF 50V C.C.	1 B
C27, 28	0510101	100 μ F	1 B
C31, 32	0510470	47 μ F	1 C, 1 B
C33, 34	0515339	3.3 μ F 50V E.C.	2 C, 2 B
C35, 36	0600336	0.0033 μ F	2 A
C37, 38	0600277	0.027 μ F	2 B
C39, 40	0600277	0.027 μ F	2 A
C41, 42	0600228	0.22 μ F	2 A
C43, 44	0660330	33pF 50V C.C.	2 B
C601	0519103	0.47 μ F 50V E.C.	1 C
C602	0660151	150pF 50V C.C.	1 C
C603	0510470	47 μ F 6.3V E.C.	1 C

Parts No.	Stock No.	Description	Position
C604	0510470	47 μ F 6.3V E.C.	1 C
C605	0519101	1 μ F 50V E.C.	2 C
C606	0657223	22000pF	1 E
C607	0657223	22000pF	1 E
C608	0657223	22000pF	1 C
C609	0657223	22000pF	1 D
C611	0514221	220 μ F 35V E.C.	1 A
C612	0513471	470 μ F	1 A
C613	0513101	100 μ F	1 A
C614	0660101	100pF 50V C.C.	2 C
R01, 02	0107103	10k Ω	2 D
R03, 04	0107105	1M Ω	2 D
R05, 06	0107222	2.2k Ω	1 E
R07, 08	0107823	82k Ω	1 E
R09, 10	0107124	120k Ω	1 E
R11, 12	0107334	330k Ω	1 E, 1 D
R13, 14	0107683	68k Ω	1 E, 1 D
R15, 16	0107271	270 Ω	1 E
R17, 18	0107184	180k Ω	1 E
R19, 20	0107123	12k Ω	2 E, 2D, E
R21, 22	0107562	5.6k Ω	1 E, 1 D
R23, 24	0107122	1.2k Ω	1 E, 1 D
R25, 26	0107124	120k Ω	1 E, 1 D
R27, 28	0107221	220 Ω	2 E
R29, 30	0107102	1k Ω	1 B, 2 E
R31, 32	0107683	68k Ω	1 D
R33, 34	0107224	220k Ω	1 D
R35, 36	0107682	6.8k Ω	1 D
R37, 38	0107470	47 Ω	1 D
R39, 40	0107124	120k Ω	1 D
R41, 42	0107222	2.2k Ω	2 D

-3900)
-4900)

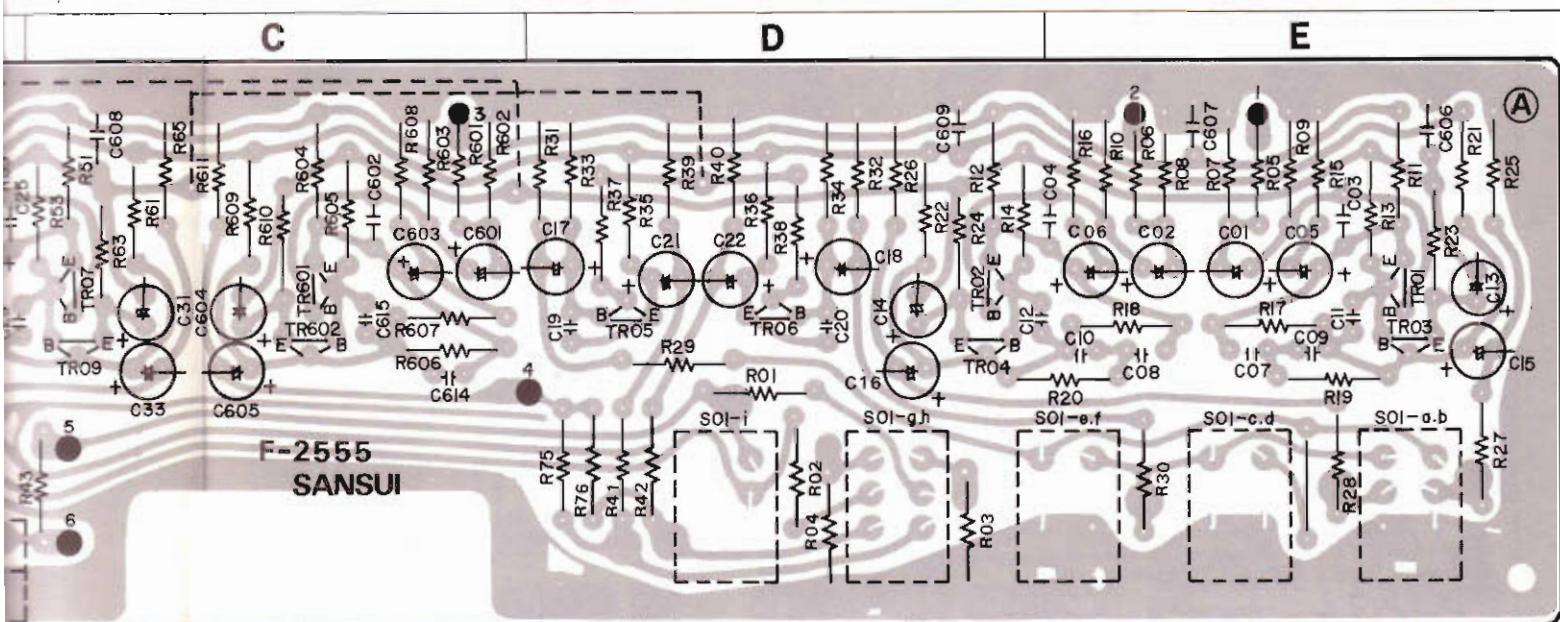

F-2555
SANSUI

Position
1 C
2 C
3 E
4 E
5 C
6 D
7 A
8 A
9 A
10 C
11 D
12 D
13 E
14 E
15 E
16 E
17 E
18 E
19 E
20 E
21 E
22 E
23 E
24 E
25 E
26 E
27 E
28 E
29 E
30 E
31 E
32 E
33 E
34 E
35 E
36 E
37 E
38 E
39 E
40 E
41 E
42 E
43 E
44 E
45 E
46 E
47 E
48 E
49 E
50 E
51 E
52 E
53 E
54 E
55 E
56 E
57 E
58 E
59 E
60 E
61 E
62 E
63 E
64 E
65 E
66 E
67 E
68 E
69 E
70 E
71 E
72 E
73 E
74 E
75 E
76 E
77 E
78 E
79 E
80 E
81 E
82 E
83 E
84 E
85 E
86 E
87 E
88 E
89 E
90 E
91 E
92 E
93 E
94 E
95 E
96 E
97 E
98 E
99 E
100 E

Position	Parts No.	Stock No.	Description	Position
	R45, 46	0107122	1.2kΩ	1 B
	R47, 48	0107105	1MΩ	1 B
	R49, 50	0107474	470kΩ	1 B
	R51, 52	0107105	1MΩ	1 C, 1 B
	R55, 56	0107273	27kΩ	2 B
	R61, 62	0107682	6.8kΩ	1 C, 1 B
	R63, 64	0107122	1.2kΩ	1 C, 1 B
	R65, 66	0107124	120kΩ	1 C, 1 B
	R67, 68	0107102	1kΩ	2 A
	R69, 70	0107153	1.5kΩ	2 A
	R71, 72	0107152	1.5kΩ	2 A
	R73, 74	0107122	1.2kΩ	2 A
	R75, 76	0107273	27kΩ	2 D
	R601	0107222	2.2kΩ	1 C
	R602	0107474	470kΩ	1 C
	R603	0107224	220kΩ	1 C
	R604	0107394	390kΩ	1 C
	R605	0107683	68kΩ	1 C
	R606	0107104	100kΩ	2 C
	R608	0107121	120Ω	1 C
	R609	0107562	5.6kΩ	1 C
	R610	0107122	1.2kΩ	1 C
	R611	0107124	120kΩ	1 C
	R612	0107472	4.7kΩ	1 A
	VR01	1015070, 1	100kΩ (M, N) × 2	2 B
	VR02	1015080, 1	100kΩ (A) × 2	2 A, B
	VR03	1015080, 1	100kΩ (A) × 2	2 A
	S01	1131120	SUB54 Push Switch	2 D, E

Parts List (AU-3900 only)

Parts No.	Stock No.	Description	Position
C610	0513470	47μF 25V E.C.	1 A, B
R53, 54	0107683	68kΩ	1 C, 1 B
R59, 60	0107471	470Ω	1 B
R613	0107331	330Ω	1 A
R614	0107820	82Ω	1 A
R615	0107471	470Ω	1 A
R616	0107681	680Ω	1 A

Parts List (AU-4900 only)

Parts No.	Stock No.	Description	Position
C29, 30	0660100	10pF 50V C.C.	1 B, 2 B
C610	0515470	47μF 50V E.C.	1 A, B
R43, 44	0107683	68kΩ	2 C, 2 B
R53, 54	0107683	68kΩ	1 C, 1 B
R59, 60	0107391	390Ω	1 B
R613	0107221	220Ω	1 A
R614	0107101	100Ω	1 A
R615	0107561	560Ω	1 A
R616	0107681	680Ω	1 A

5-2. F-2554 Driver Circuit Board Conductor Side

(Stock No. 7571151 Complete Circuit Board F-2554...AU-3900)
(Stock No. 7571161 Complete Circuit Board F-2554...AU-4900)

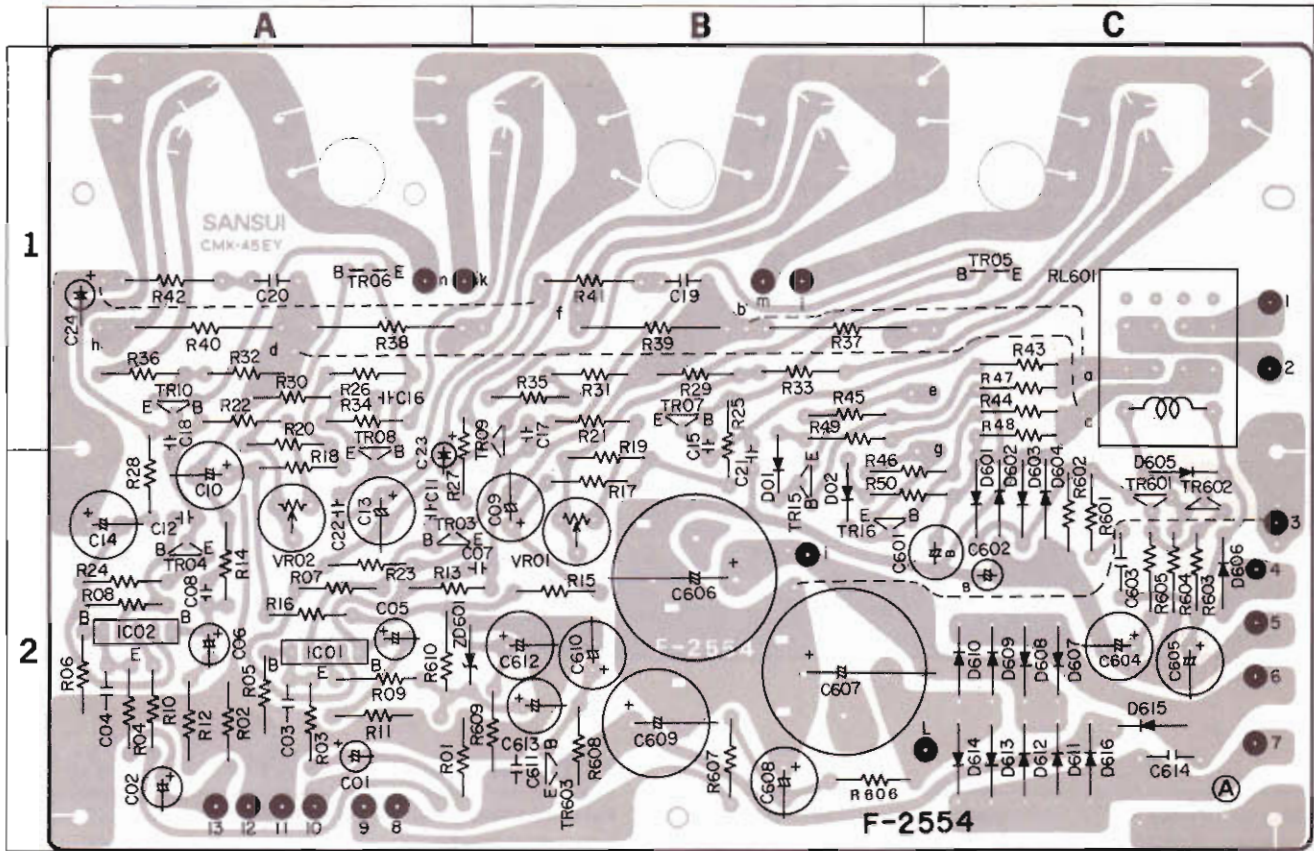

Parts List (AU-3900, 4900)

Parts No.	Stock No.	Description	Position	Parts No.	Stock No.	Description	Position
TR03, 04	0306360, 1	2SC1951 (I, 2)	2A, B, 2A	C05, 06	0510470	47μF 6.3V E.C.	2A
TR05, 06	0305731	2SC711 (E)	1C, 1A	C07, 08	0660309	3pF 50V C.C.	2B, 2A
TR07	0308521	2SD438 (E)	1B	C09, 10	0515330	33μF 50V E.C.	2B, 1, 2A
	0308522	2SD438 (F)		C11, 12	0660390	39pF 50V C.C.	2A
TR08	0308521	2SD438 (E)	1, 2A	C13, 14	0515470	47μF 50V E.C.	2A
	0308522	2SD438 (F)		C15, 16	0660470	47pF 50V C.C.	1, 2B, 1A
TR09	0303361	2SB560 (E)	1, 2A	C17, 18	0660470	47pF 50V C.C.	1B, 1A
	0303362	2SB560 (F)		C19, 20	0601477	0.047μF 50V M.C.	1B, 1A
	0303361	2SB560 (E)		C21, 22	0657103	10000pF 50V C.C.	1, 2B, 2A
TR10	0303362	2SB560 (F)	1A	C23, 24	0515109	1μF 50V E.C.	1, 2A, 1A
	0303361	2SB560 (E)		C601	0530470	47μF 6.3V E.C.	2B, C
TR15, 16	0305731, 2	2SC711 (E, F)	2B	C602	0535109	1μF 50V E.C.	2C
TR601	0306131, 2	2SC1364 (6, 7)	2C	C603	0601228	0.22μF 50V M.C.	2C
TR602	0306131, 2	2SC1364 (6, 7)	2C	C604	0510471	470μF 6.3V E.C.	2C
TR603	0306131, 2	2SC1364 (6, 7)	2B	C605	0514101	100μF 35V E.C.	2C
IC01, 02	0360290, 1	2SA798 (F, G)	2A	C608	0514101	100μF 35V E.C.	2B
D01, 02	0311160	1S2473D	1, 2B, 2B	C610	0514101	100μF 35V E.C.	2B
D601	0310400	1N34A	2C	C611	0657223	22000μF 50V C.C.	2B
D602	0310400	1N34A	2C	C612	0514101	100μF 35V E.C.	2B
D603	0310400	1N34A	2C	C613	0512470	47μF 16V E.C.	2B
D604	0310400	1N34A	2C	C614	0659011	10000pF 500V C.C.	2C
D605	0310340	10D1 (1S2226)	2C	R01, 02	0107474	470kΩ	2A, B, 2A
D606	0310340	10D1 (1S2226)	2C	R03, 04	0107222	2.2kΩ	2A
D607	0310350	10D2 (1S2227)	2C	R05, 06	0107393	39kΩ	2A
D609	0310350	10D2 (1S2227)	2C	R07, 08	0107152	1.5kΩ	2A
ZD601	0315970	EQA01-13R Zener Diode	2A, B	R09, 10	0107123	12kΩ	2A
C01, 02	0519101	1μF 50V E.C.	2A	R11, 12	0107122	1.2kΩ	2A
C03, 04	0660221	220pF 50V C.C.	2A	R13, 14	0107393	39kΩ	2A
				R15, 16	0107182	1.8kΩ	2B, 2A
				R17, 18	0107472	4.7kΩ	2B, 2A
				R19, 20	0107332	3.3kΩ	2B, 1A

Parts No.	Stock No.	Description	Position
R21, 22	0107821	820Ω	1 B. 1 A
R23, 24	0107330	33Ω	2 A
R25, 26	0107390	39Ω	1, 2B, 1 A
R27, 28	0107101	100Ω	1, 2 A
R29, 30	0107221	220Ω	1 B. 1 A
R31, 32	0107221	220Ω	1 B. 1 A
R33, 34	0107689	6.8Ω	1 B. 1 A
R35, 36	0107689	6.8Ω	1 B. 1 A
R37, 38	0132338	0.33Ω	1 B. 1 A
R39, 40	0132338	0.33Ω	1 B. 1 A
R41, 42	0103479	4.7Ω	1 B. 1 A
R43, 44	0107681	680Ω	1 C
R47, 48	0107473	47kΩ	1 C
R49, 50	0107222	2.2kΩ	1B, 2B, C
R601	0107394	390kΩ	2 C
R602	0107224	220kΩ	2 C
R603	0107683	68kΩ	2 C
R604	0107100	10Ω	2 C
R605	0107220	22Ω	2 C
R606	0107151	150Ω	2 B
R607	0107100	10Ω	2 B
R608	0107103	10kΩ	2 B
R609	0107220	22Ω	2 B
RL601	{ 1150101 1150280	{ MY4-02-US RABK-4B-DC24V-151T	Relay 1 C
VR01, 02	1035070	1kΩ (B) Semi-Variable Resistor	2 B, 2 A

Parts List (AU-3900 only)

Parts No.	Stock No.	Description	Position
TR11	{ 0308551 or 0308552	{ 2SD315V10 (D) or 2SD315V10 (E)	Transistor
TR12	{ 0308551 or 0308552	{ 2SD315V10 (D) or 2SD315V10 (E)	
TR13	{ 0303351 or 0303352	{ 2SB509V10 (D) or 2SB509V10 (E)	
TR14	{ 0303352 or 0303352	{ 2SB509V10 (D) or 2SB509V10 (E)	
D611	0310350	10D-2 (1S2227)	2 C
D613	0310350	10D-2 (1S2227)	2 C
D615	0310350	10D-2 (1S2227)	2 C
D616	0310350	10D-2 (1S2227)	2 C
C606	0549007	3300μF	2 B
C607	0549007	3300μF	2 B
C609	0514221	220μF	2 B
R610	0107152	1.5kΩ	2 A
R45, 46	0107331	330Ω	1B, 2B, C
	5937082	Heat Sink	

Parts List (AU-4900 only)

Parts No.	Stock No.	Description	Position
TR11	{ 0308541 or 0308542	{ 2SD188A (R) or 2SD188A (Q)	Transistor
TR12	{ 0308541 or 0308542	{ 2SD188A (R) or 2SD188A (Q)	
TR13	{ 0303381 or 0303382	{ 2SB545A (R) or 2SB545A (Q)	
TR14	{ 0303381 or 0303382	{ 2SB545A (R) or 2SB545A (Q)	

Parts No.	Stock No.	Description	Position
D11	0310350	10D-2 (1S2227)	Diode
D12	0310350	10D-2 (1S2227)	
D13	0310350	10D-2 (1S2227)	
D14	0310350	10D-2 (1S2227)	
D15	0310350	10D-2 (1S2227)	
D16	0310350	10D-2 (1S2227)	
D608	0310350	10D-2	2 C
D610	0310350	10D-2 (1S2227)	2 C
C606	0549110	3300μF	2 B
C607	0549110	3300μF	50V E.C. 2 B, C
C609	0515221	220μF	2 B
R45, 46	0107271	270Ω	1/4 W C.R. 1B, 2B, C
R610	0107272	2.7kΩ	
	5937220	Heat Sink	2 A

5-3. F-2556 Switch Circuit Board

(Stock No. 7592811 Complete Circuit Board F-2556..AU-3900)
(Stock No. 7592821 Complete Circuit Board F-2556..AU-4900)

Conductor Side

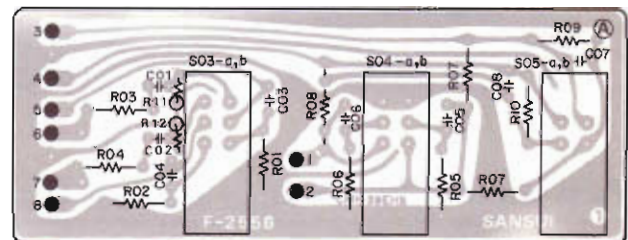

Parts List (AU-3900, 4900)

Parts No.	Stock No.	Description
C01, 02	0621561	560pF 50V P.C.
C03, 04	0600157	0.015μF
C05, 06	0600127	0.012μF
		50V M.C.
R01, 02	0107223	22kΩ
R03, 04	0107153	15kΩ
R05, 06	0107104	100kΩ
R07, 08	0107222	2.2kΩ
R901, 902	0107105	1MΩ
S03	1170340	SX15-5
S04	1170350	SX15-6
		Lever Switch

Parts List (AU-4900 only)

Parts No.	Stock No.	Description
C07, 08	0600397	0.039μF 50V M.C.
R09, 10	0107474	470kΩ 1/4 W C.R.
S05	1170340	SX15-5 Lever Switch

Abbreviations:

C.R. : Carbon Resistor	BP.E.C.: Bi-Polar Electrolytic Capacitor
S.R. : Solid Resistor	C.C. : Ceramic Capacitor
Ce.R. : Cement Resistor	Mi.C. : Metallized Film Resistor
M.R. : Metallized Film Resistor	O.C. : Oil Capacitor
M.C. : Mylar Capacitor	P.C. : Polystyrene Capacitor
E.C. : Electrolytic Capacitor	E.C. : Tantalum Capacitor

5-4. F-2587 Connector Circuit Board

(Stock No. 7592831 Complete Circuit Board F-2587 . . AU-3900)

(Stock No. 7592841 Complete Circuit Board F-2587 . . AU-4900)

Conductor Side

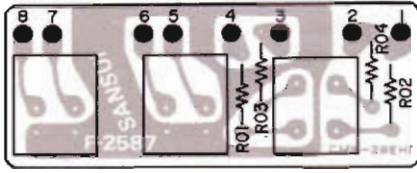

Parts List (AU-3900, 4900)

Parts No.	Stock No.	Description
R01, 02	0107222	2.2kΩ } 1/4 W C.R.
R03, 04	0107562	5.6kΩ }

6. FIGURES

SEMICONDUCTORS	COMPLETE CIRCUIT BOARD	SEMICONDUCTORS	COMPLETE CIRCUIT BOARD
2SD438 2SC1364 2SB560 2SC1951	F-2554	IN34A	F-2554
2SC711 2SA726 2SC1313	F-2555 F-2554	10D-1 10D-2	F-2554
2SB509 2SD188A 2SB545A 2SD315	F-2554	1S2473D	F-2554
2SA798	F-2554	EQA01-13R	F-2554

7. TROUBLESHOOTING

7-1. Troubleshooting Chart

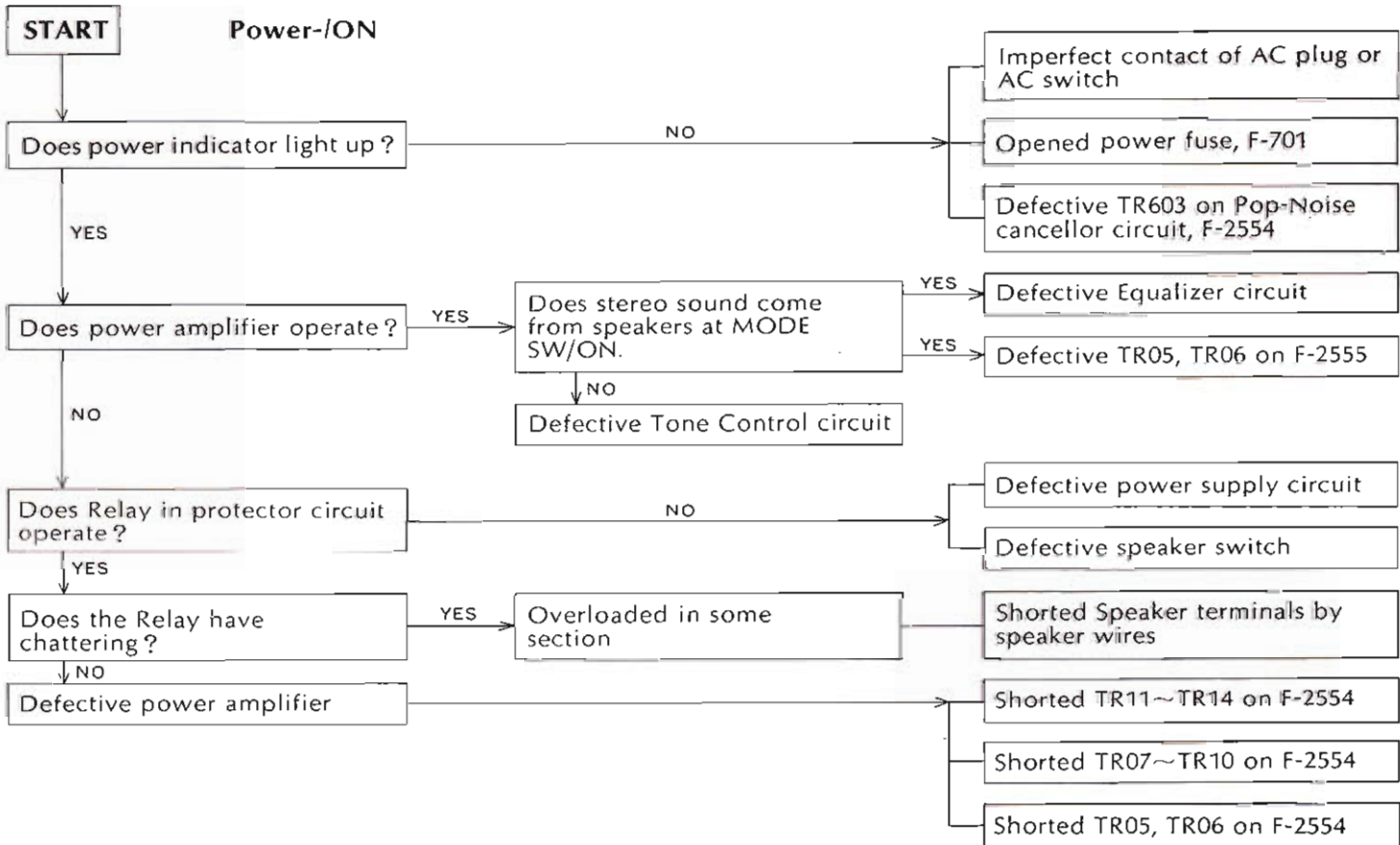

7-2. Operation Block Diagram

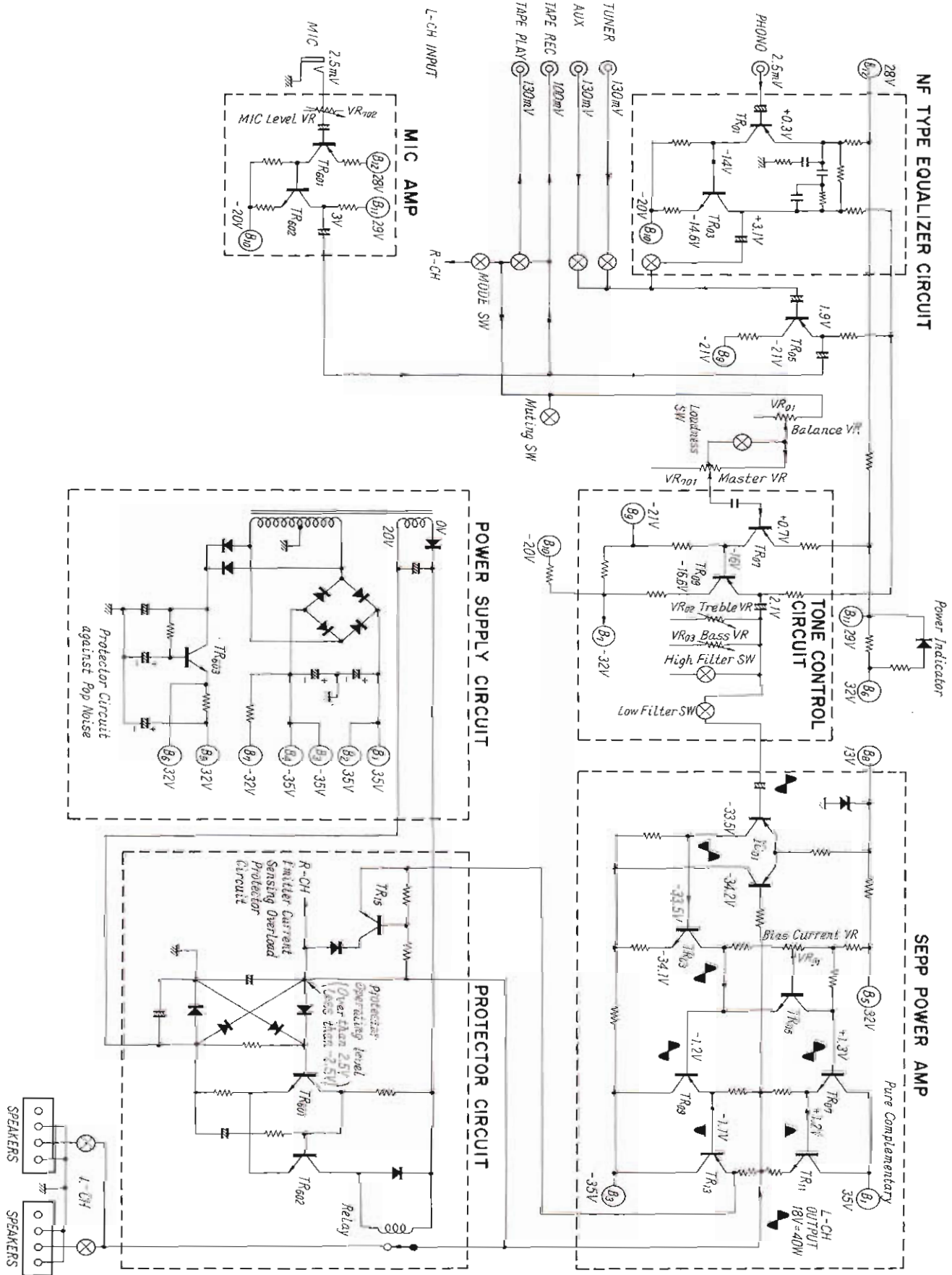

8. SCHEMATIC DIAGRAM

8-1. AU-3900

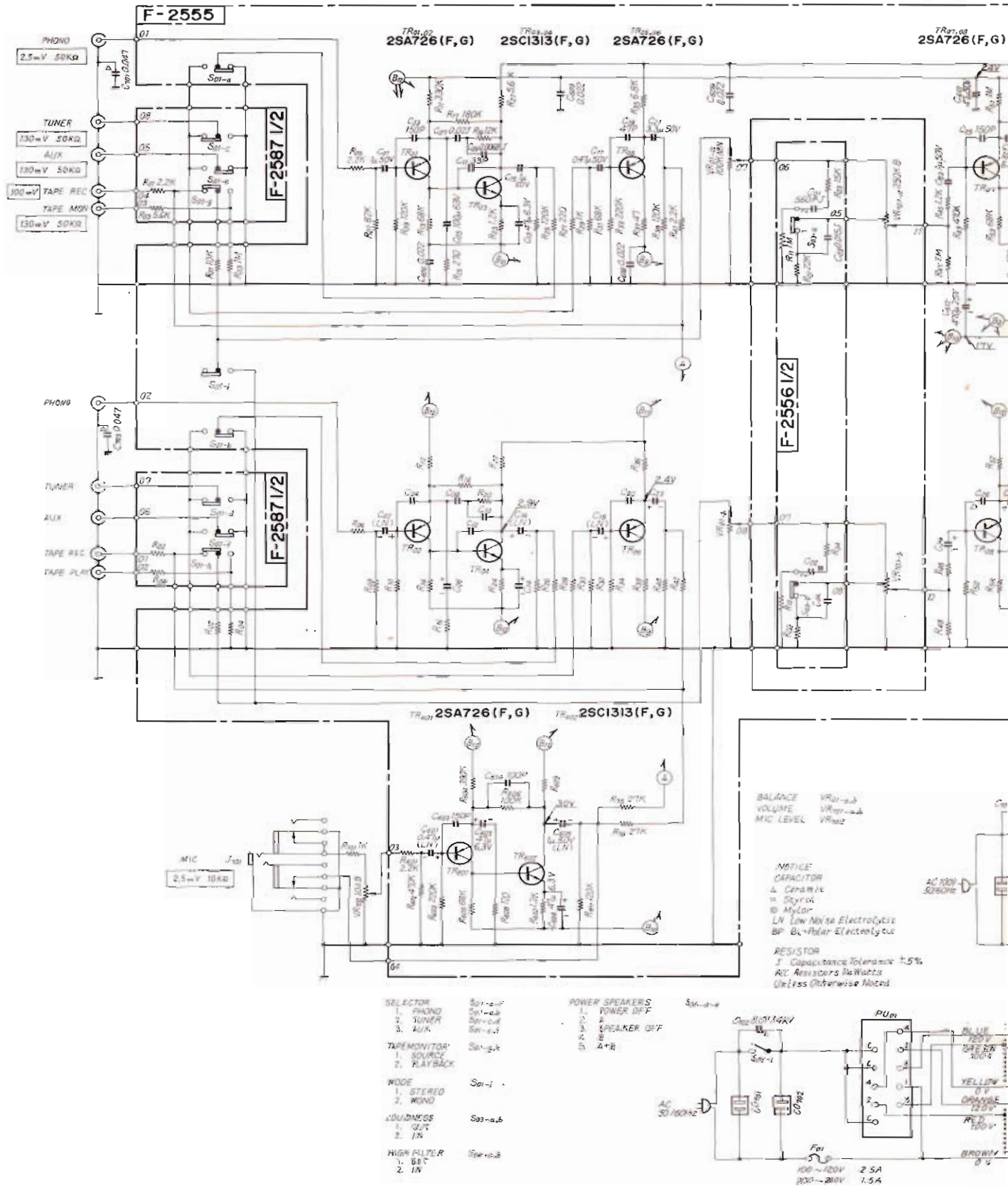

- * La présentation et les spécifications sont susceptibles d'être modifiées sans préavis par suite d'améliorations éventuelles.
- * Änderungen, die dem technischen Fortschritt dienen, bleiben vorbehalten.
- * Design and specification subject to change without notice for improvements.

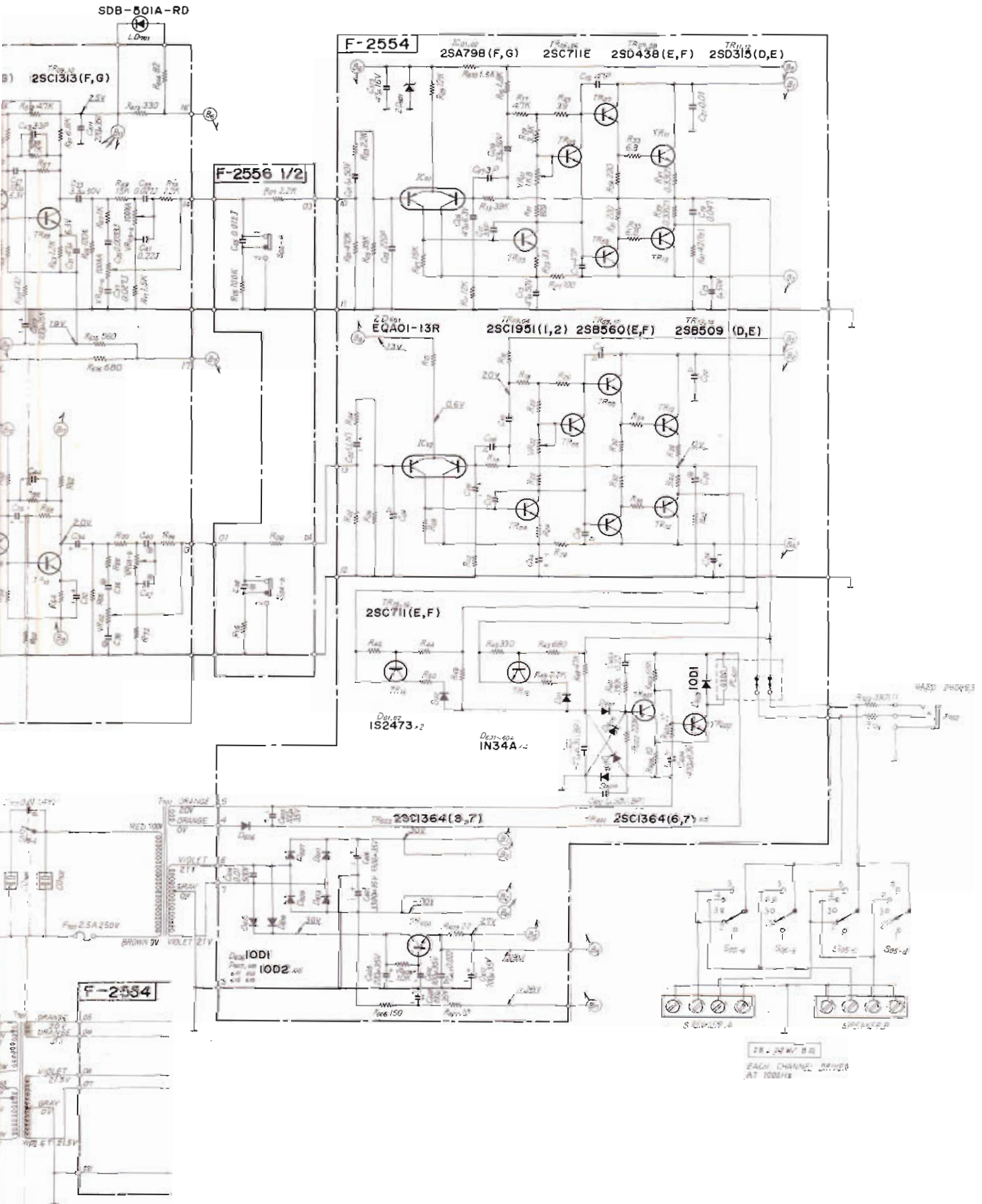

8-2. AU-4900

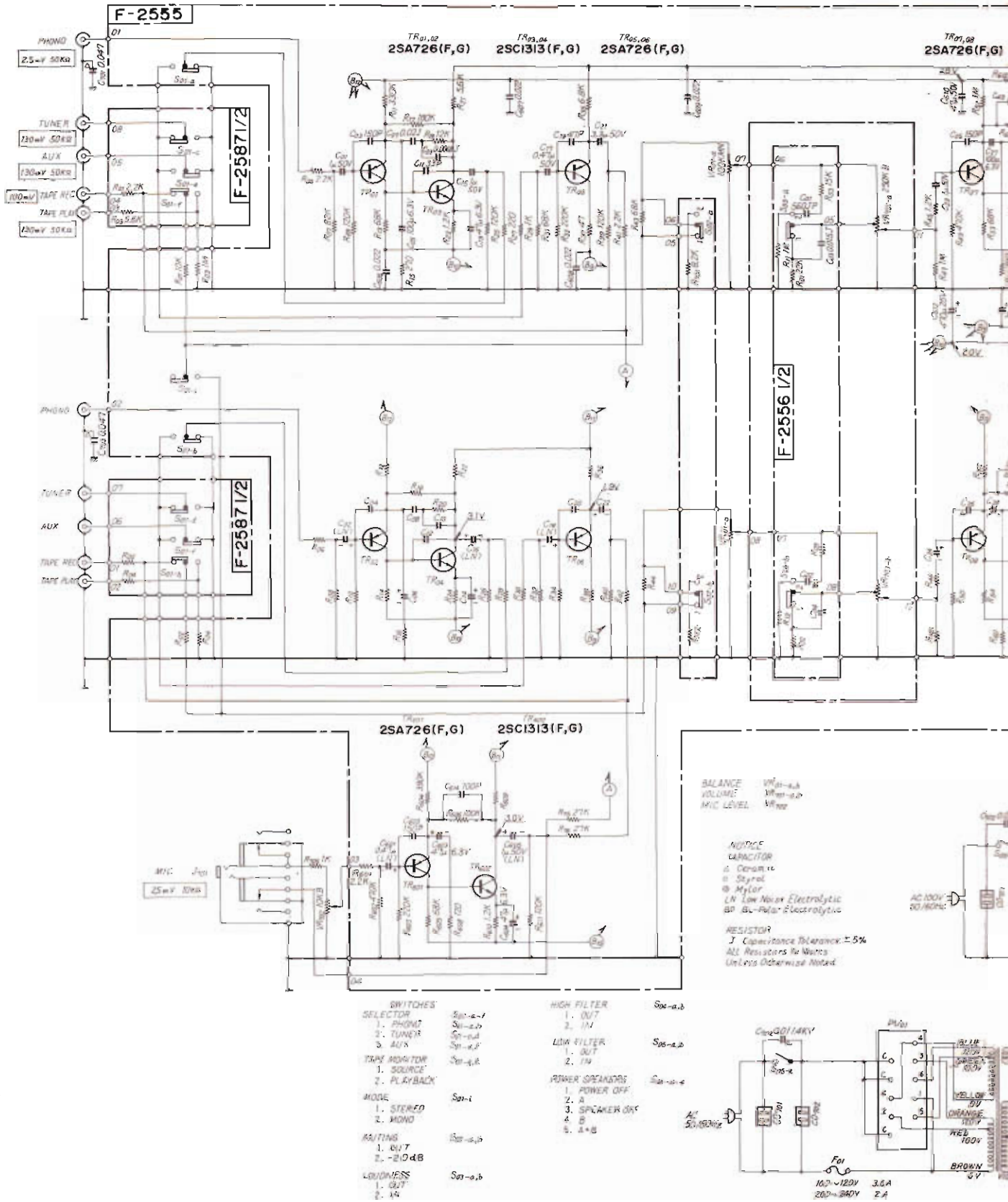

* La présentation et les spécifications sont susceptibles d'être modifiées sans préavis par suite d'améliorations éventuelles.
 * Änderungen, die dem technischen Fortschritt dienen, bleiben vorbehalten.
 * Design and specification subject to change without notice for improvements.

